



TECHNICAL DATA KIT

MAX FLOW [M3/H]	12
MAX FLOW (LPM)	201
MAX HEAD	92
WORKING AIR TEMP	0°C – 40°C
LIQUID TEMPERATURE	-15°C – 120°C
MAXIMUM PUMP PRESSURE	33 Bar

PER PUMP SPECIFICATIONS

RATED VOLTAGE CURRENT	Three Phase 415V +10% - 6%
RATED CURRENT	4.41 AMPS
POWER (KW)	2.2 kW 2 Pole
CAPACITOR	N/A
MOTOR IP RATING	IP55
MOTOR INSULATION	Class F
MOTOR EFFECIENCY STD	IE3
MOTOR EFFECIENCY	84.2%
COS ϕ	0.84
MECHANICAL SEAL	AS-L-12
OUTLET DIN FLANGE	DN32

INCLUDES

- VMS Pump
- NXT Drive (Variable Frequency Drive)
- Counter Flange (In DN25 to DN65)
- Fiber Gasket to suit counter flanges
- Watermarked Spring Check Valve
- Manifold (304 Stainless Steel)
- Pressure Transducer
- 30 Bar Liquid Filled Pressure Gauge
- Galvanised Single/Double/Triple
- Ball Valve (304 Stainless Steel)
- Pressure Tank Included in Scope of Supply
- Braided Hose 20 Bar 1.5m 1" BSPF (10/6 only)

DIMENSIONS

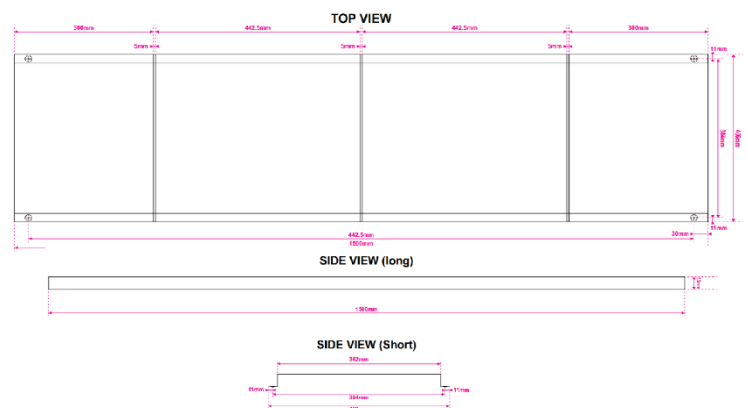

CURVE

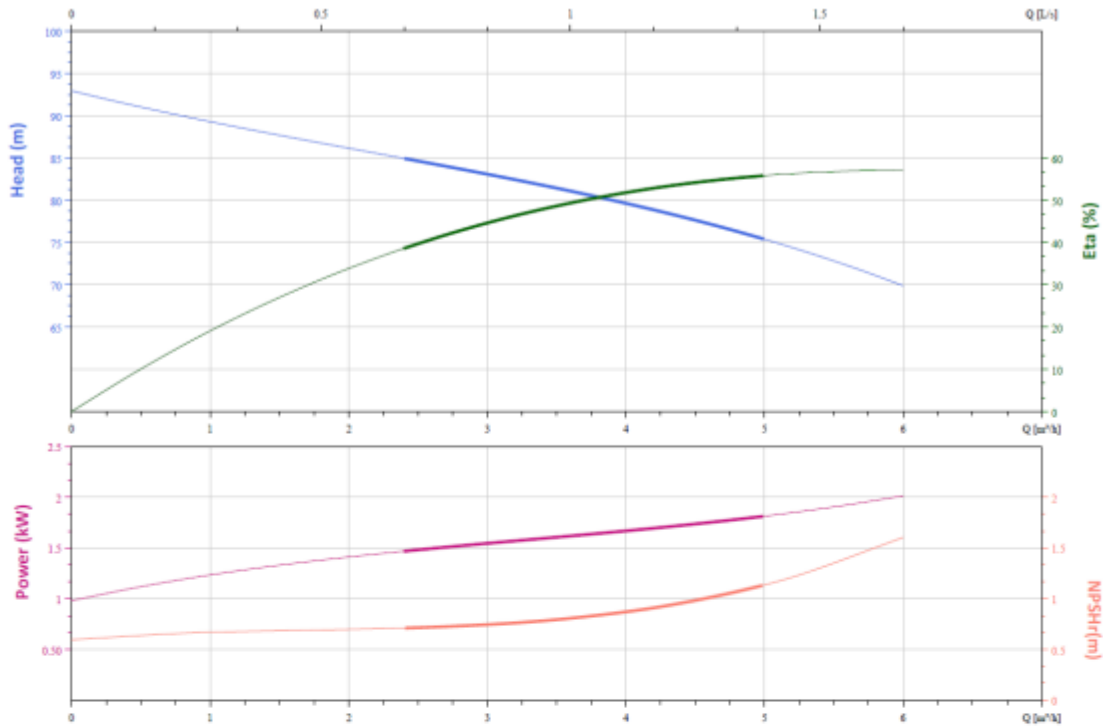

VFD CURVE

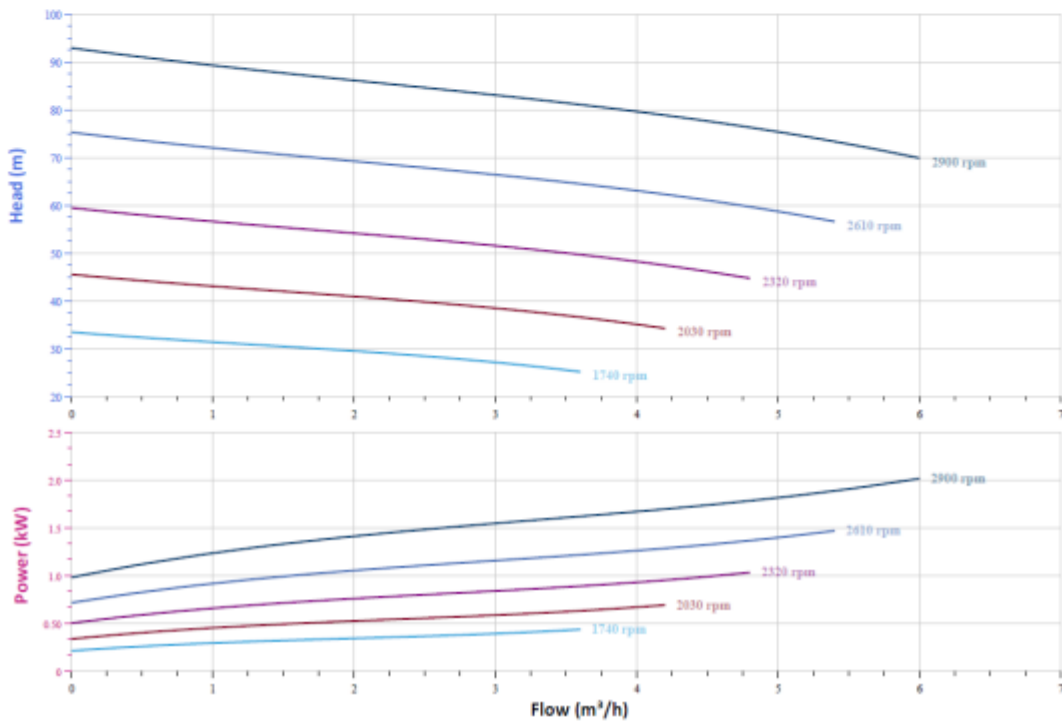

DUAL PUMP CURVE

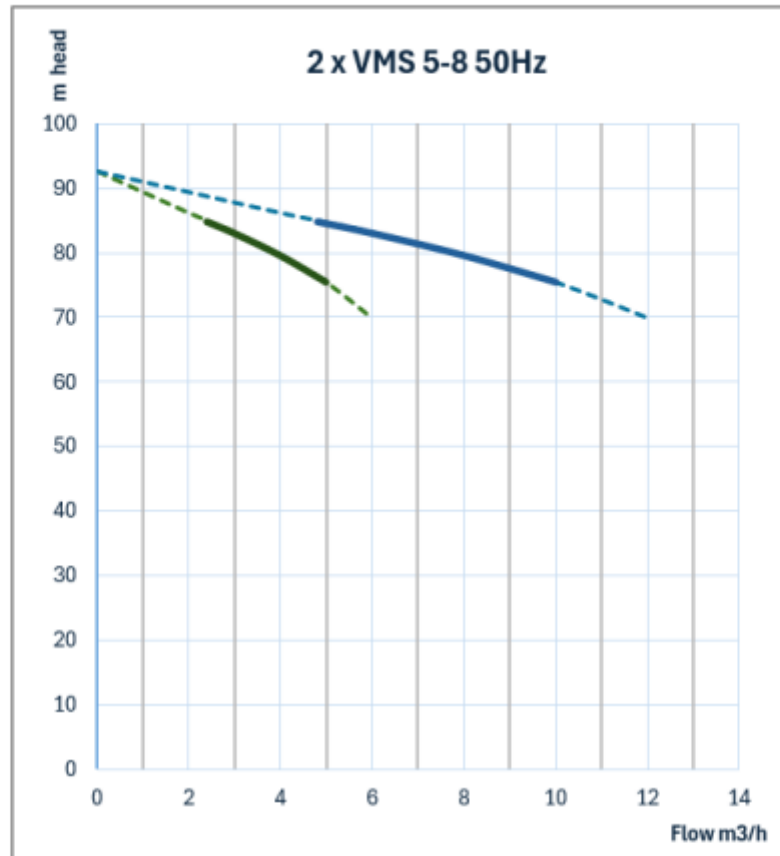

CUTAWAY AND MATERIALS

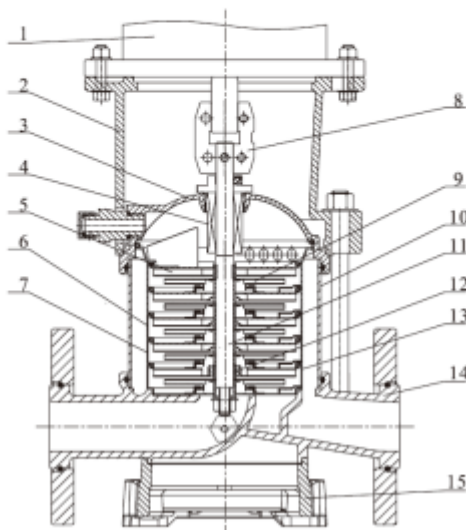

1	Motor	/
2	Bracket	Ductile Cast Iron
3	Seal Base	Stainless / Ductile Cast Iron
4	Mechanical Seal	AS-L-16
5	Top Diffuser	Stainless Steel
6	Diffuser	Stainless Steel
7	Support Diffuser	Stainless Steel
8	Coupling	Stainless Steel
9	Impeller	Stainless Steel
10	Cylinder	Stainless Steel
11	Shaft	Stainless Steel
12	Intermediate Bearing	SIC / WC
13	Inducer	Stainless Steel
14	Inlet/Outlet Chamber	Stainless Steel / Ductile Cast Iron
15	Base	Ductile Cast Iron

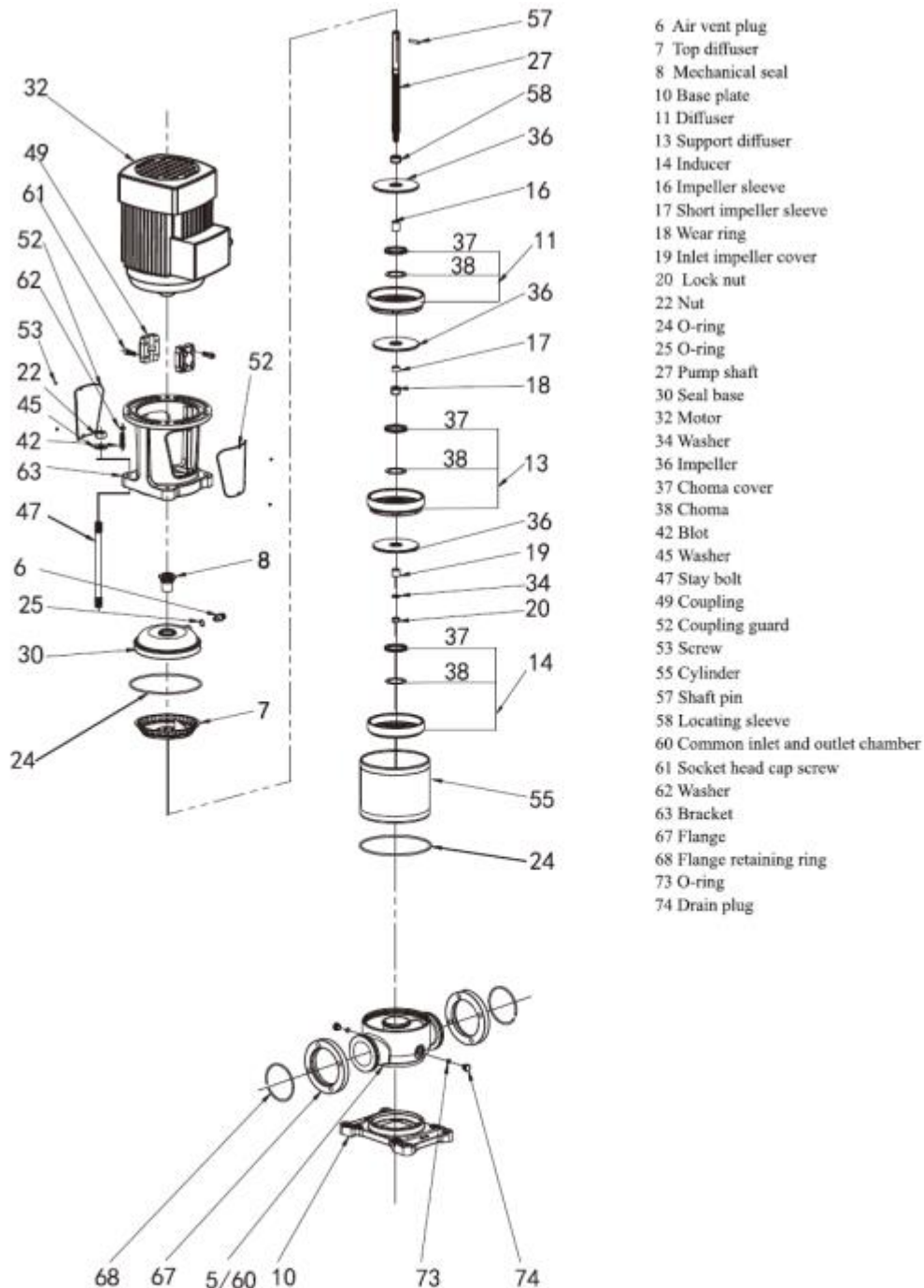

- 6 Air vent plug
- 7 Top diffuser
- 8 Mechanical seal
- 10 Base plate
- 11 Diffuser
- 13 Support diffuser
- 14 Inducer
- 16 Impeller sleeve
- 17 Short impeller sleeve
- 18 Wear ring
- 19 Inlet impeller cover
- 20 Lock nut
- 22 Nut
- 24 O-ring
- 25 O-ring
- 27 Pump shaft
- 30 Seal base
- 32 Motor
- 34 Washer
- 36 Impeller
- 37 Choma cover
- 38 Choma
- 42 Blot
- 45 Washer
- 47 Stay bolt
- 49 Coupling
- 52 Coupling guard
- 53 Screw
- 55 Cylinder
- 57 Shaft pin
- 58 Locating sleeve
- 60 Common inlet and outlet chamber
- 61 Socket head cap screw
- 62 Washer
- 63 Bracket
- 67 Flange
- 68 Flange retaining ring
- 73 O-ring
- 74 Drain plug

WARRANTY / CERTIFICATIONS

